

SC-615BS

Paging Horn Speaker 15W EN/ISO/BS



DESCRIPTION

The SC-615BS Paging Horn Speaker is designed for both indoor and outdoor applications, as a 15 W, high-impedance (70 V/100 V lines) system. Its diaphragms employ special heat-resistant polyamide film to prevent shape-changing moisture absorption. A minimal gap between diaphragm bobbin and magnetic circuitry slit enhances efficiency. Mounting brackets and all external hardware are stainless steel. This, together with the horn treated with a 50-micron thick powdered paint coating, gives the speaker excellent weatherproofing and corrosion resistance. The aluminium external horn flare offers better shock resistance than resin. EN 54-24* and ISO 7240-24 certified, the SC-615BS is authorized for use in fire detection systems. It is also in compliance with BS 5839-8: 2008 14.8.

*EN 54-24: Loudspeaker for voice alarm systems for fire detection and fire alarm systems.

FEATURES

- Stainless steel brackets and hardware and powder coated horn ensure superb weatherproofing and corrosion resistance
- Shock-resistant aluminium oval horn
- Input impedance selector with rotary switch
- Unobtrusive off-white colour (RAL 9010) helps match surroundings.
- IP65 standard complied for dust tight and jet-water proof rating
- EN 54-24 and ISO 7230-24 certified (Certificate No.: 0359-CPD-0109)
- In compliance with BS 5839-8: 2008 14.8
- Ideally suited for voice alarm system applications

APPEARANCE AND DIMENSIONAL DIAGRAM

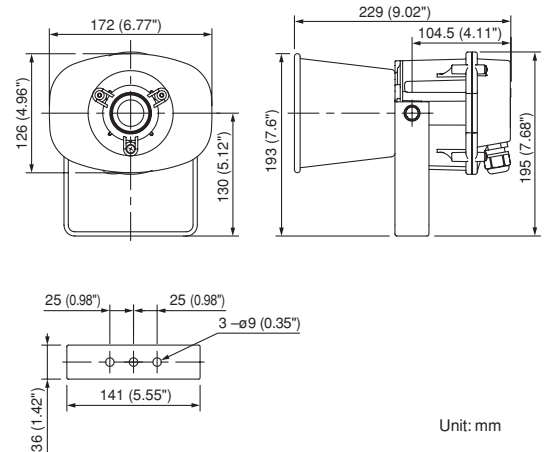

SPECIFICATIONS

Rated Noise Power:	15 W (100 V line and 70 V line)
Rated Impedance:	100 V line: 670 Ω (15 W), 1k Ω (10 W), 2k Ω (5 W), 3.3k Ω (3 W) 70 V line: 330 Ω (15 W), 670 Ω (7.5 W), 1k Ω (5 W), 2k Ω (2.5 W), 3.3k Ω (1.5 W)
Sensitivity:	109 dB (1 W, 1 m) (500 – 2,500 Hz, peak level) 100 dB (1 W, 1 m) (100 – 10,000 Hz, pink noise) 88 dB (1 W, 4 m) (100 – 10,000 Hz, pink noise)
Maximum Sound Pressure Level:	110 dB (15 W, 1 m) (100 – 10,000 Hz, pink noise) 98 dB (15 W, 4 m) (100 – 10,000 Hz, pink noise)
Frequency Response:	315 Hz – 12,500 Hz
Coverage Angle:	Horizontal: 360° (500 Hz), 160° (1,000 Hz), 85° (2,000 Hz), 45° (4,000 Hz) Vertical: 360° (500 Hz), 200° (1,000 Hz), 115° (2,000 Hz), 60° (4,000 Hz)
Environmental Type:	B (outdoor applications)
Operating Temperature:	-20° C to +55° C (-4° F to 131° F)
Dust/Water Protection:	IP65
Speaker Mounting -Method:	Wall-mount
Cable Gland:	Size: PG 13.5 One cable gland is factory-installed, For bridge connection, one cable gland can be added.*
Applicable Cable Size:	Outer diameter: ø 8 – 12.5 mm Conductor: Solid wire or 7-core wire No bridge connection: 0.8 – 10 mm ² (AWG 18 – AWG 7) for solid wire, 0.8 – 8 mm ² (AWG 18 – AWG 8) for 7-core wire Bridge connection: 0.8 – 2.5 mm ² (AWG 18 – AWG 13) for solid wire, 0.8 – 1.5 mm ² (AWG 18 – AWG 15) for 7-core wire
Cable Connection:	Screw terminal (steatlite), can be bridge-connected
Finish:	Horn flare: Aluminium, off-white, powder coating Reflector horn, Trans case and Terminal cover: ABS resin, off-white Bracket, screw and bolts: Stainless steel
Dimensions:	172 (W) × 195 (H) × 229 (D) mm (6.77" × 7.68" × 9.02")
Weight:	1.5 kg (3.31 lb)
Accessory:	Terminal cover × 1
Option:	Swivel bracket: YS-151S (Can be used instead of the supplied bracket.)

* Part code for Cable gland: 525-52-011-70 Cable gland AVC PGB13.5-12 (GRY)
Note: Never connect the 330 Ω position ton the 100 V line.

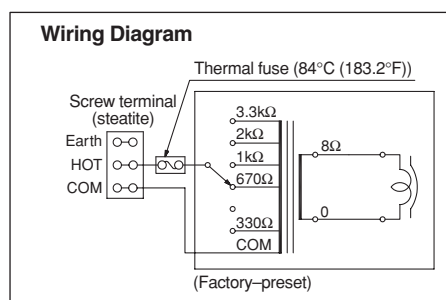

CHARACTERISTIC DIAGRAMS based on EN 54-24 measurement conditions (Pink noise, 1 W, 4 m)

Polar Response (Horizontal)

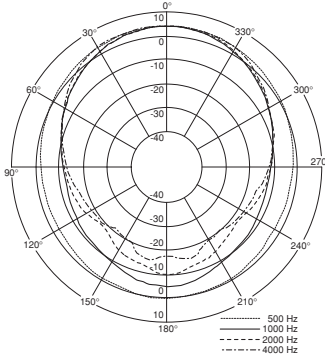

Polar Response (Vertical)

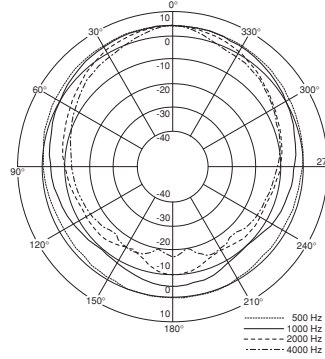

SPL vs. Frequency

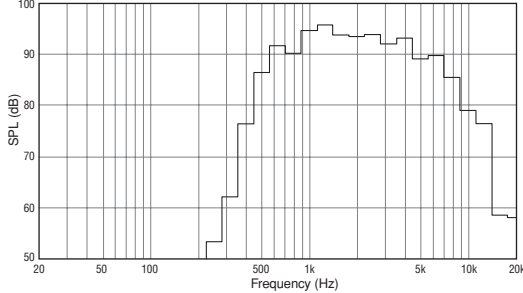

Beamwidth vs. Frequency

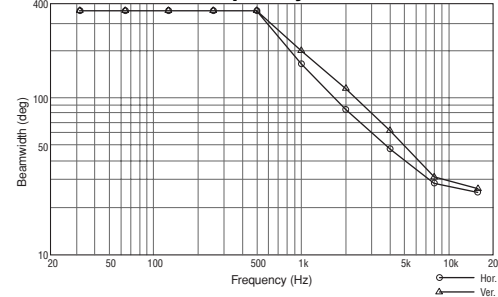

Directivity Factor vs. Frequency

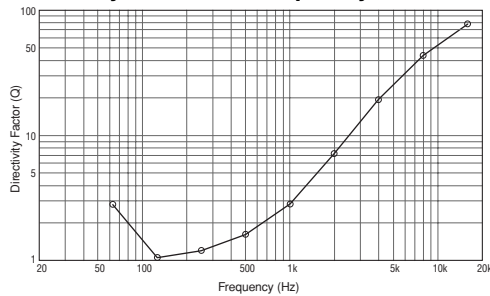

ARCHITECTURAL AND ENGINEERING SPECIFICATIONS

The speaker shall be a weatherproof horn speaker suitable for both indoor and outdoor applications. It is also designed for use in voice evacuation systems.

Rated input shall be 15 W. Input impedance shall be easily adjustable with rotary switch on the rear side of the speaker. The speaker shall include a transformer having multiple taps (3 W, 5 W, 10 W, 15 W at 100 V and 1.5 W, 2.5 W, 5 W, 7.5 W, 15 W at 70 V) adjustable.

The sensitivity at a distance of 1 m with a 1 W input level applied shall be 109 dB, high efficiency. The speaker shall have a frequency response of 315 – 12,500 Hz. Horizontal and vertical dispersion at -6 dB below the on-axis reference at 2,000 Hz shall be 85° (H) x 115° (V). The speaker shall have an operating temperature of -20° C to +55° C.

The speaker diaphragms shall be employing special heat-resistant polyamide film to prevent the diaphragm from absorbing moisture and changing shape.

The speaker shall have enhances excellent speech clarity. The mounting brackets and all external hardware (screws, bolts) shall be made of stainless steel.

The speaker shall have excellent weatherproofing and corrosion resistance. The speaker shall have an IEC 60529 / EN 60529 dust tight and jet-water proof rating of IP65. The external horn flare shall be made of aluminium, which shall have more shock resistant than resin.

A fire-resistant steatite screw terminal block with thermal fuse with a blowing temperature of 84°C allows secure cable connections and bridge wiring. Internal cables shall be flame-resistant insulation. Fire Rated Cable can be directly connected to the speaker cabinet via PG13.5 (or 20 mm) cable gland.

The switch is also equipped with an OFF position to prevent speaker damage resulting from incorrect impedance setting.

The speaker shall be certified according to EN 54-24 with CPD Number 0359-CPD-0109, certified according to ISO 7240-24 and in compliance with the British Standard BS 5839-8

The speaker shall be a TOA model SC-615BS.



TOA Corporation
www.toa.jp